



Product Overview

Downlight Lamp recessed ceiling type DLC Series. The lamp can adjust the direction of the beam for 45 degrees. The lamp works with the installation of LED bulb LED MR16 GU5.3 by operating with emergency lighting control system. Central battery Systems of 24VDC in case of power failure, will provide emergency lighting for escape.

Technical Specifications

Model	DL-C 24-109
Input Voltage	24VDC
LED Lamp Power	9W
Lumen (lm) / Bulb	810
Lamp Type	LED MR16
Base	GU5.3
CCT	Warm White (3000K ± 250K) Daylight (6000K ± 250K)
CRI	>80
Lamp Life Time	50,000 Hrs
Beam Angle	50 Degree
IP Rating	20
Dimension LxWxH (mm)	103 x 103 x 60
Material	Diecasting aluminium
Weight (g)	190
Hole cut (mm)	90
Lamp Warranty	10 Year
Mounted	Recessed Ceiling

Dimensions (mm)

FRONT VIEW

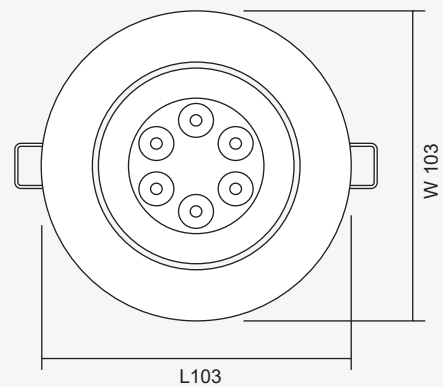

SIDE VIEW

